

May 11, 1943.

T. J. MURPHY
AMUSEMENT DEVICE

2,318,958

Filed Sept. 29, 1941

2 Sheets-Sheet 1

Fig. 1.

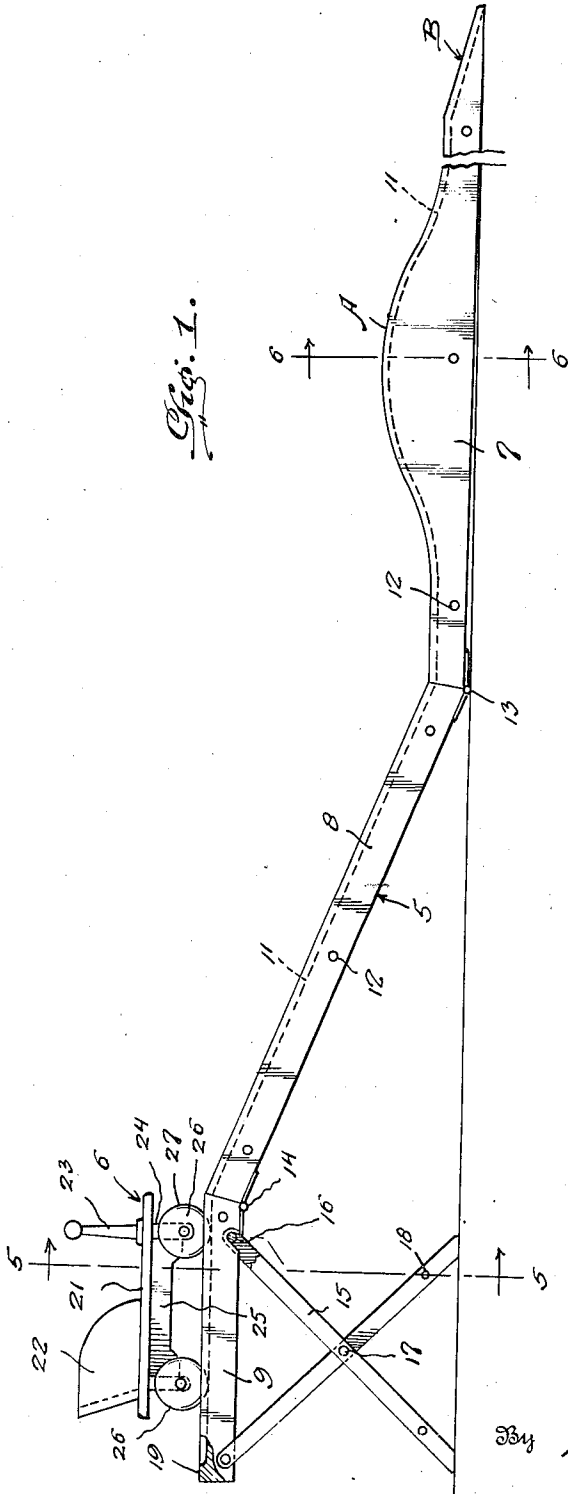

Fig. 2.

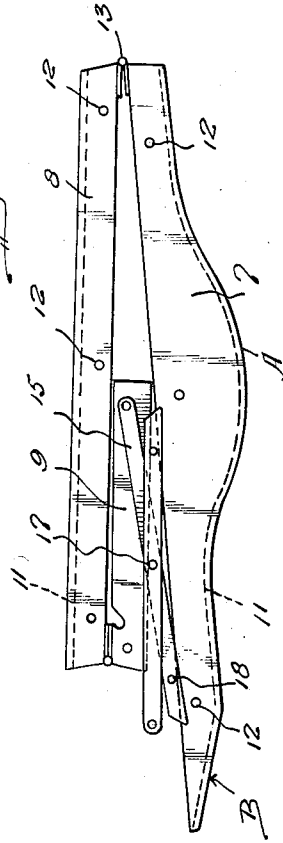
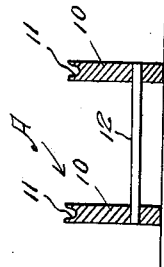

Fig. 3.



Inventor
T. J. Murphy,

BY *McNarrow & Bertram*
Attorneys

May 11, 1943.

T. J. MURPHY

2,318,958

AMUSEMENT DEVICE

Filed Sept. 29, 1941

2 Sheets-Sheet 2

Fig. 2.

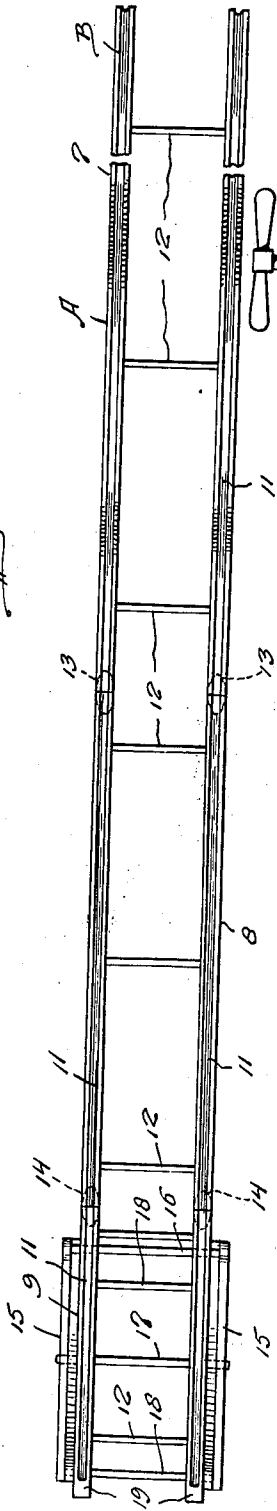

Fig. 5.

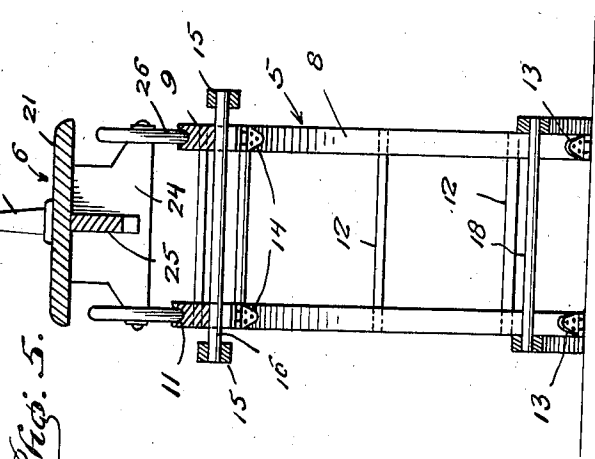

Fig. 4.

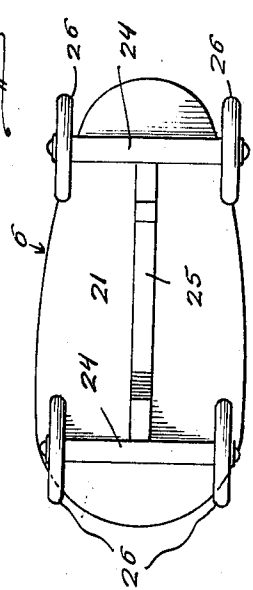
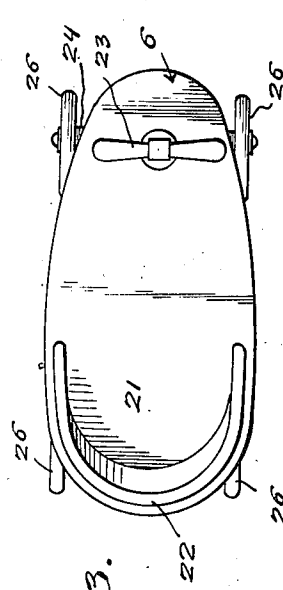

Fig. 3.



Inventor
T. J. Murphy,

By *McMorrow & Berwan*
Attorneys.

UNITED STATES PATENT OFFICE

2,318,958

AMUSEMENT DEVICE

Thomas J. Murphy, Liberty, N. Y.

Application September 29, 1941, Serial No. 412,865

1 Claim. (Cl. 104—53)

This invention relates to amusement devices for children, and has for the primary object the provision of a device of this character which is in the form of a coaster, that will afford a maximum amount of amusement for children of different ages and includes a car and a track therefor over which the car bearing a child may travel by gravitation with safety, the device being so constructed that it may be easily and quickly set up for use and may be folded to facilitate carrying and storing thereof when not in use.

With these and other objects in view as will become more apparent as the description proceeds, the invention consists in certain novel features of construction, combination and arrangement of parts as will be hereinafter more fully described and claimed.

For a complete understanding of my invention, reference is to be had to the following description and accompanying drawings, in which

Figure 1 is a side elevation, partly in section, illustrating an amusement device in operative position and constructed in accordance with my invention.

Figure 2 is a top plan view showing the device in operative position.

Figure 3 is a top plan view illustrating the car.

Figure 4 is a bottom plan view illustrating the car.

Figure 5 is a transverse sectional view taken on the line 5—5 of Figure 1.

Figure 6 is a transverse sectional view taken on the line 6—6 of Figure 1.

Figure 7 is a side elevation illustrating the device in a folded or inoperative position.

Referring in detail to the drawings, the numeral 5 indicates a track over which may move a car 6 bearing a child by gravitation. The track 5 is composed of a ground or floor section 7, an inclined section 8 and a platform section 9. The sections 7, 8 and 9 are composed of rail members 10 each provided in its upper edge with a groove or channel 11. The track members are tied together by braces 12. The number of braces employed may be varied to meet different conditions or situations under which the device is used.

Hinges 13 connect the sections 7 and 8 and hinges 14 connect the sections 8 and 9. The ends of the rail members of the sections are cut at angles so that the section 7 may rest substantially horizontally on the floor or ground while the section 8 inclines upwardly therefrom and the section 9 is disposed horizontally and supported by pairs of cross legs 15 pivoted thereto, as shown

at 16. Braces 17 connect the pairs of cross legs for pivotal movement and further the legs may be connected by braces 18. The pairs of cross legs will firmly support the platform 9 in a horizontal elevated position upon the ground or floor.

It will be noted that the grooves or channels 11 formed in the track members of the platform section 9 terminate short of one end to form stops 19 to prevent the car 6 from rolling off of the platform section.

The rail members of the section 7 have humped portions A which will cause the car 6 when passing thereover to rise and descend rapidly and the free ends of the rail members of the section 7 are tapered, as shown at B to permit the car to roll off of the track members of the section 7 onto the floor or ground with comparative smoothness.

In operation, with the device set up as shown in Figure 1 a child takes a seated position on the car and by a slight shove to the car it is caused to roll off of the platform 9 onto the inclined section 8 where the car picks up speed and passes from the section 8 onto the section 7. The car passing over the section 7 is caused to rise and descend rapidly before leaving the section 7 so as to increase the thrill to the child in the use of the device.

The car 6 includes a platform 21, a portion of which forms a seat with a back 22 preferably of the bucket type. The forward portion of the platform is equipped with a handle bar arrangement 23. Front and rear axles 24 are secured on the platform 21 and connected to each other by a brace 25. Wheels 26 are journaled on the axles and have ribbed peripheries 27 to fit in the channels of the grooves 11 of the track members.

The wheels constructed as specified and operating within the channels or grooves of the track members permit the car to pass rapidly over the track assembly with safety.

A device of the character described in detail and shown in the drawings is simple in construction and will permit a child to easily assemble or set said device up for use either indoors or out of doors and will afford a maximum amount of amusement to the child. Whenever it is desired to carry the device or store the same in a comparatively small space, the pairs of legs are first folded under the platform section 9 and then said section 9 is swung under the section 8. The section 7 is then swung under the legs and section 9 to assume a position as shown in Figure 7, providing an extremely compact device.

While I have shown and described the preferred

embodiment of my invention, it will be understood that minor changes in construction, combination and arrangement of parts may be made without departing from the spirit and scope of the invention claimed.

Having thus described the invention, what I claim is:

In a child's coasting device, a track assembly over which a child-carrying car is adapted to travel and including intermediate and end sections and each section consisting of rails tied together in parallelism and the rails of one of the end sections having convex curved portions thereto and provided at one end of said latter named section with tapered end portions, hinges 15 connecting the end sections to the intermediate

section, pairs of crossed pivotally connected legs supporting one of the end sections elevated and horizontally with the intermediate section inclining downwardly therefrom and the other end section resting horizontally on the ground, means 5 pivoting one leg of each pair of legs to the elevated end section and the latter-named end section having notches to receive the end of the other leg of each pair of legs whereby said legs 10 may be folded to lie under said elevated section, said intermediate section and the ground engaging end section adapted to be folded toward each other with the folded legs and the other end section lying therebetween.

THOMAS J. MURPHY.